

15 Compartment Mailroom Sorter

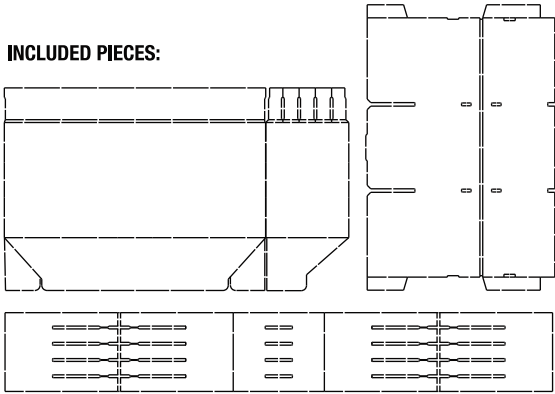

INCLUDED PIECES:



1 Face the back opening towards you as shown.

2 Fold down flap A.

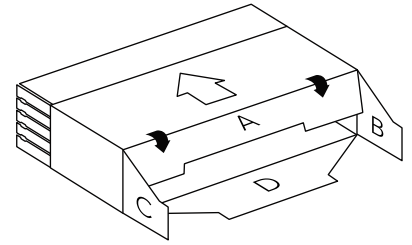
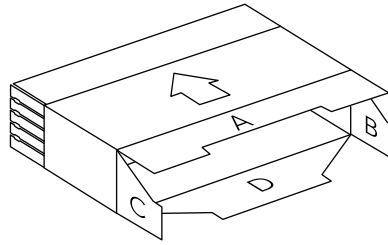

3 Fold in flaps B and C then fold up flap D and insert its tab into the slot created by flaps A, B and C.

4 With the front of the sorter facing you, fold flaps E & F inwards.

5 Fold the divider along its four creases, making a "U" shape.

6 Insert the divider into the sorter.

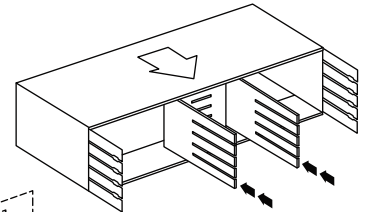
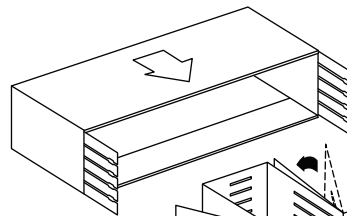
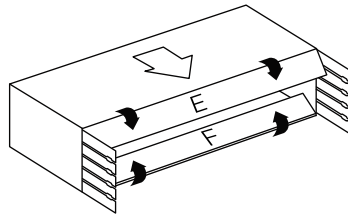
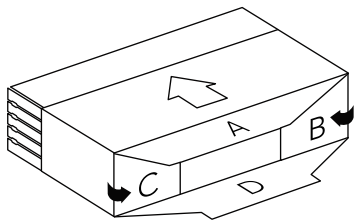

7 Fold each shelf along its crease, ensuring that the tabs face outward.

8 Align the slits of a shelf with those of the divider then insert the shelf into the box.

9 Fold in the first row's left & right tabs.

10 Repeat steps 9 & 10 with the remaining shelves.

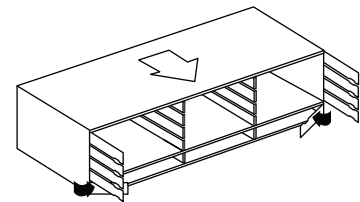
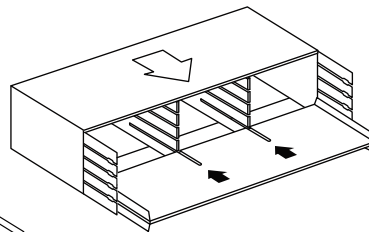
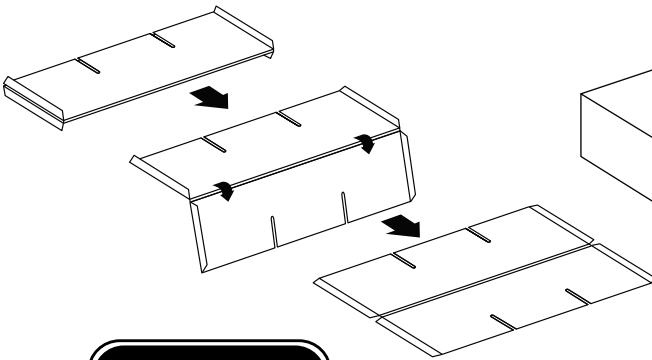

SCAN THIS QR CODE
TO ACCESS
ASSEMBLY VIDEOS
OR VISIT
youtube.com/storexindustries

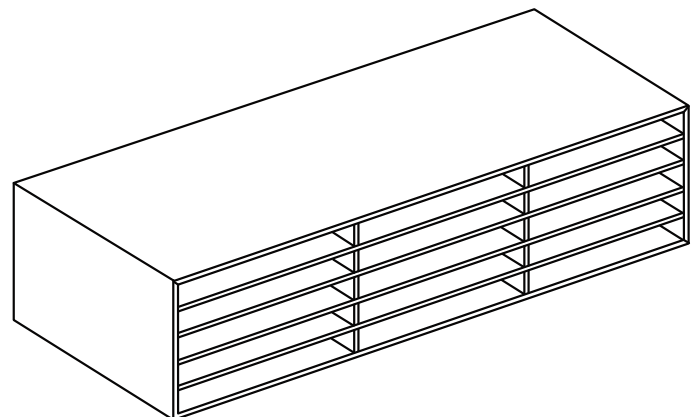

Trieuse postale à 15 compartiments



PIÈCES INCLUS:

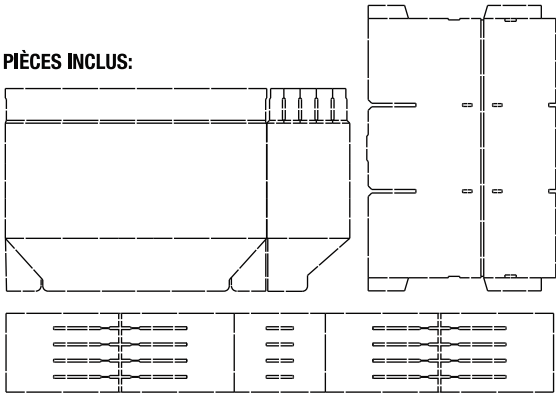

1 Tourner la boîte afin que l'ouverture arrière est face à vous.

2 Pliez let rabat A vers l'intérieur

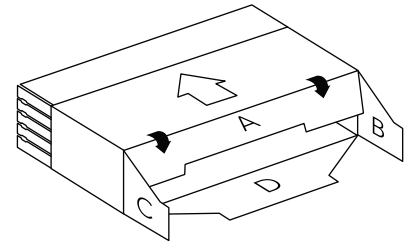
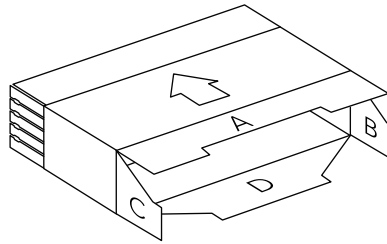

3 Pliez les rabats B et C vers l'intérieur en suite pliez le rabat D et insérez son languette dans la fente créée par les rabats A B et C

4 Pliez les rabats E et F vers l'intérieur.

5 Rabattez le diviseur le long de ses quatre plis.

6 Insérez le diviseur dans la boîte.

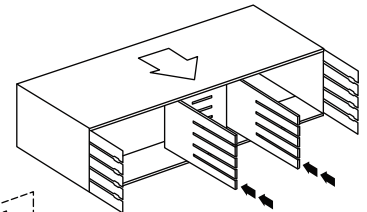
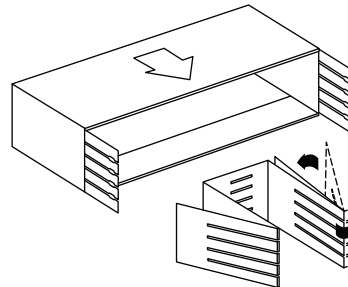
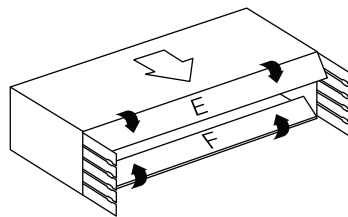
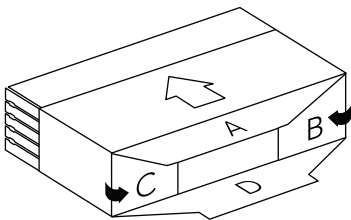

7 Rabattez chaque étage le long de son pli, assurant que les languettes seront face à l'extérieur.

8 Alignez les fentes de l'étage avec celles du diviseur ensuite insérez le diviseur dans la boîte.

9 Rabattez les languettes latérales de la première rangée.

10 Répétez les étapes 9 et 10 avec les étages qui restent.

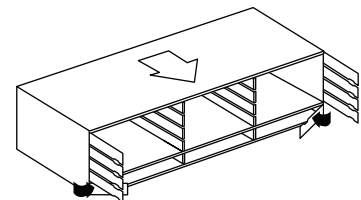
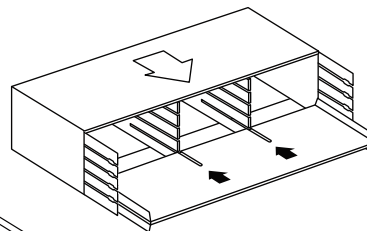
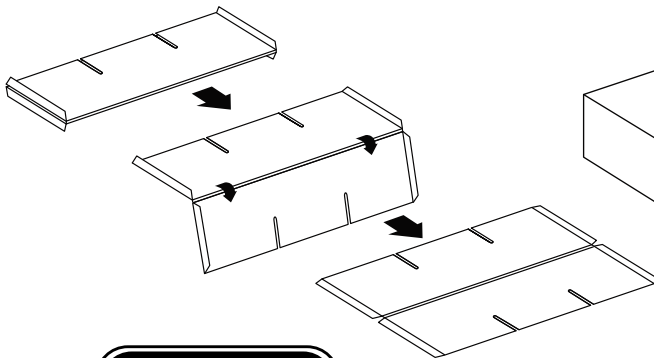

SCANNEZ CE CODE QR
POUR ACCÉDER AUX
VIDÉOS D'ASSEMBLAGE
OU VISITEZ
youtube.com/storexindustries

